

So verladen Sie Coils richtig.

Coilmulde 7.040 mm



INNOVATING FOR YOU

1 x 30,0 t

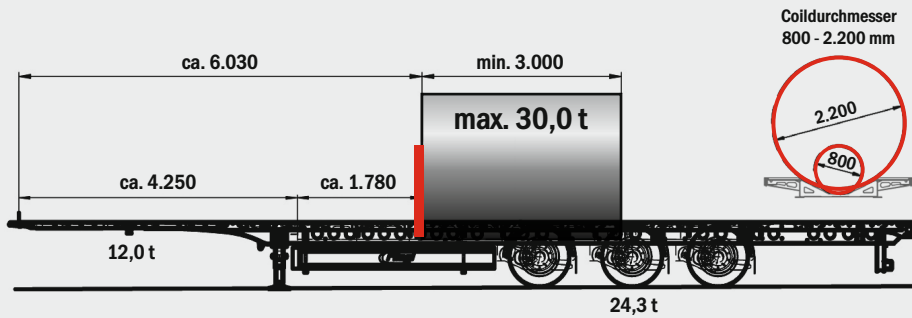

1 x 27,0 t

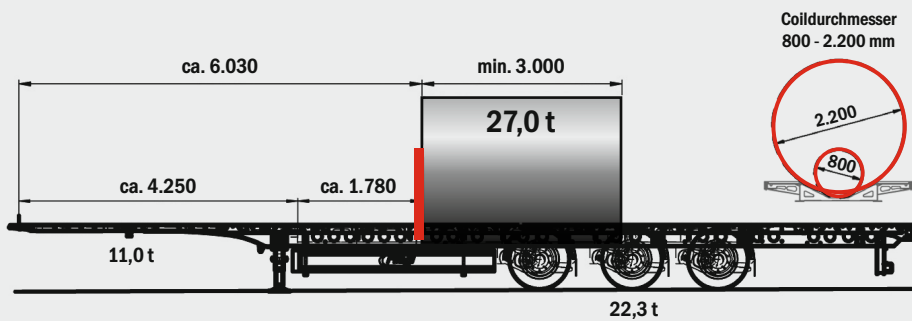

2 x 12,5 t

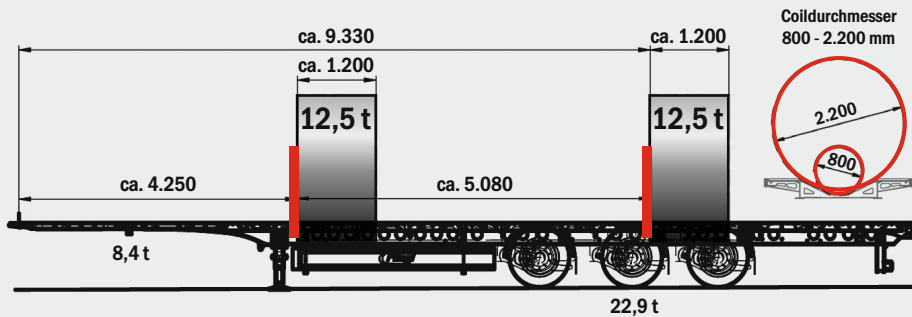

3 x 8,3 t

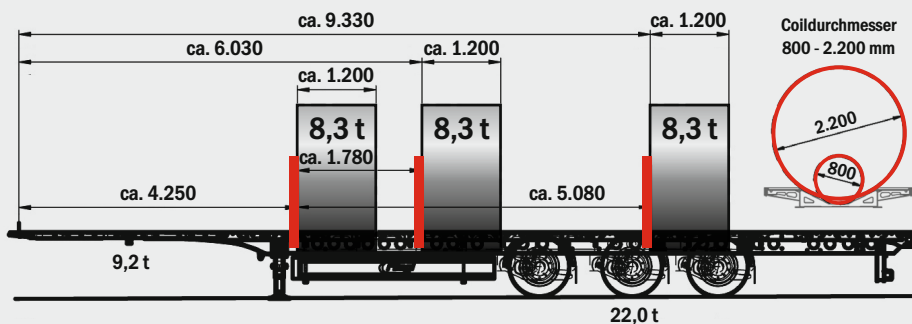

4 x 6,0 t

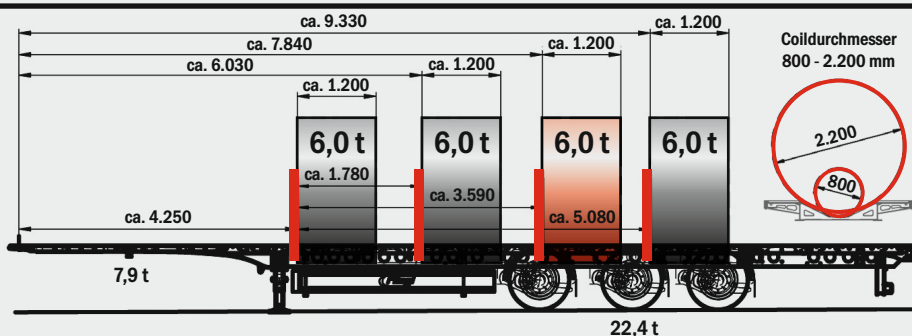

Achtung! Diese Variante ist keine Standardanwendung. Sie kann nur mit einem vierten Paar Coilstützen (Option) realisiert werden.

So verladen Sie Coils richtig.

Coilmulde 8.040 mm



INNOVATING FOR YOU

1 x 30,0 t

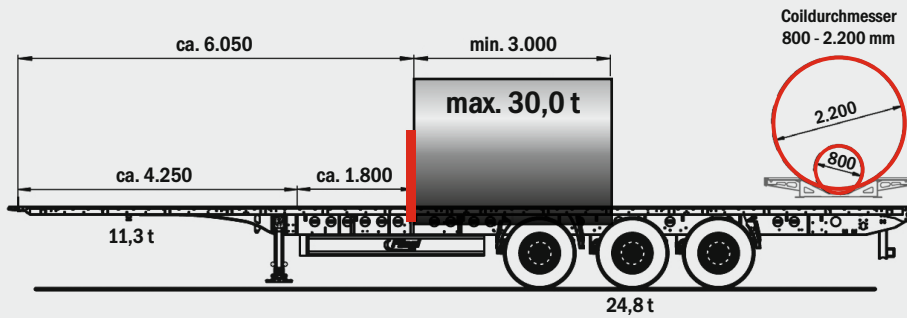

1 x 27,0 t

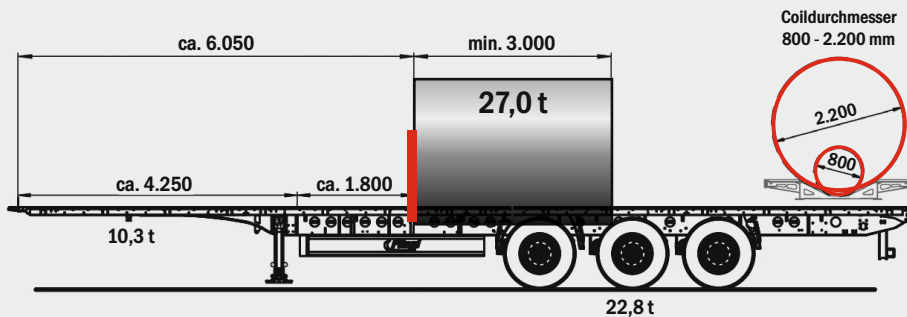

2 x 12,5 t

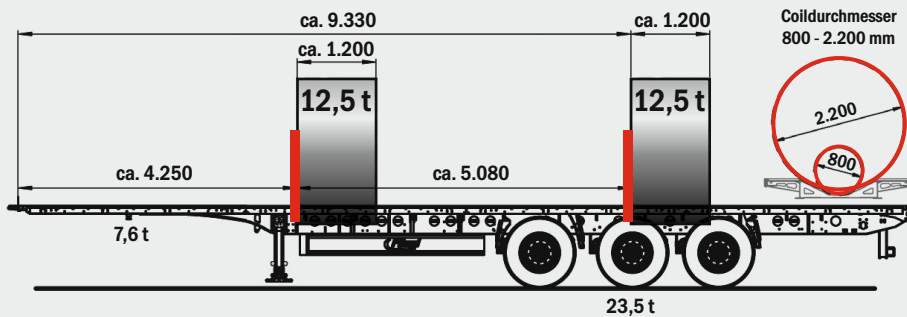

3 x 8,3 t

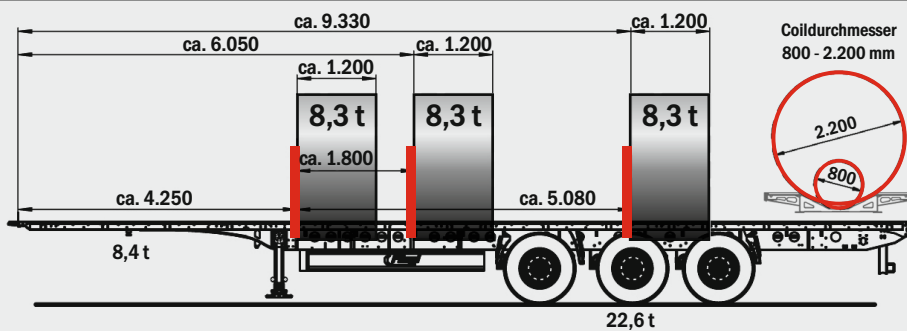

4 x 6,0 t

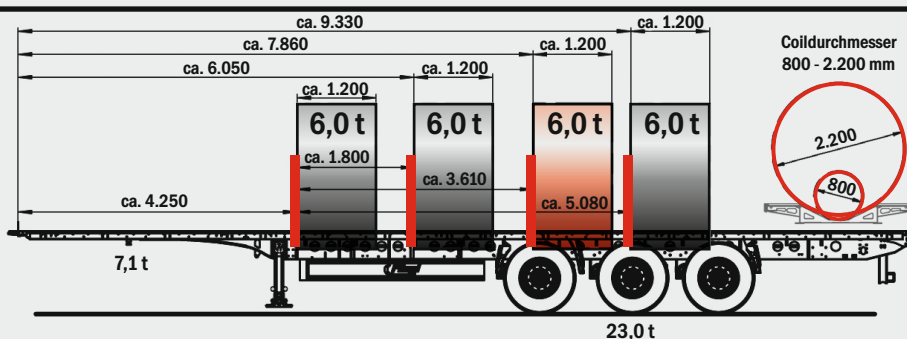

Achtung! Diese Variante ist keine Standardanwendung. Sie kann nur mit einem vierten Paar Coilstützen (Option) realisiert werden.

So verladen Sie Coils richtig.



INNOVATING FOR YOU

Coil X-TRA Short – Coilmulde 7.040 mm

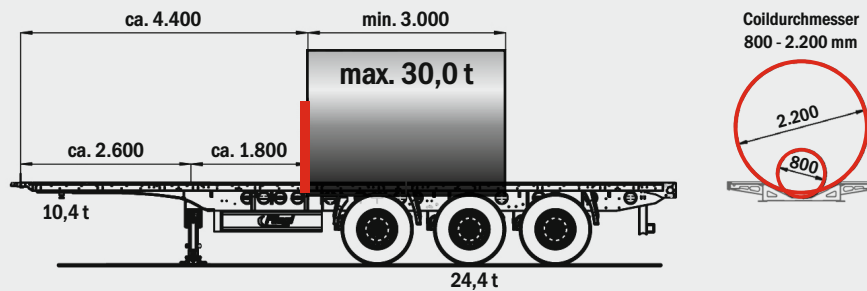

1 x 30,0 t

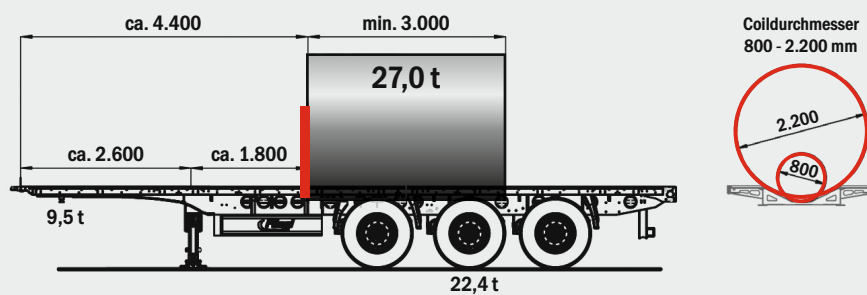

1 x 27,0 t

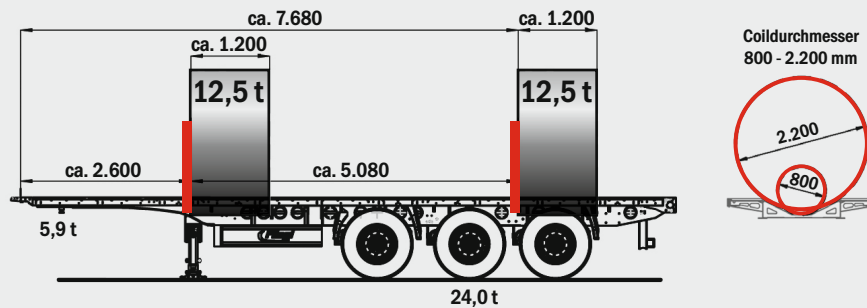

2 x 12,5 t

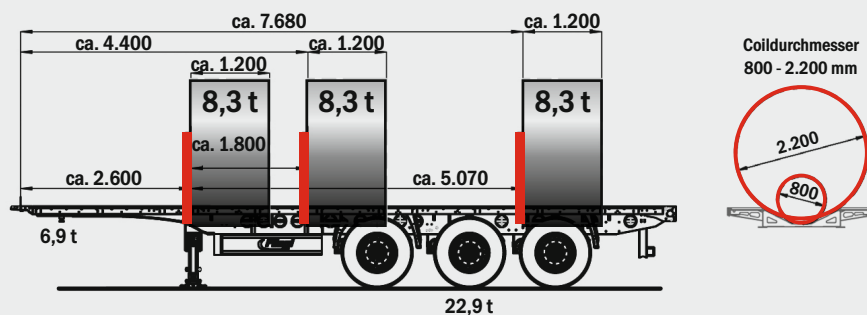

3 x 8,3 t

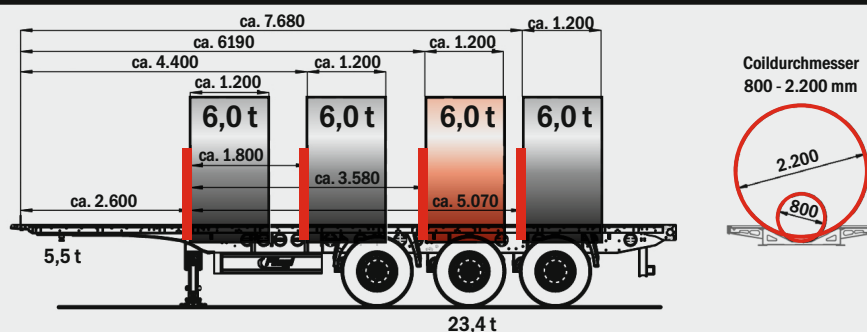

4 x 6,0 t

Achtung! Diese Variante ist keine Standardanwendung. Sie kann nur mit einem vierten Paar Coilstützen (Option) realisiert werden.